

# MasterPatio

Lift-Slide System



Reynaers  
Aluminium

Windows.  
Doors.  
Façades.

Together for better

[www.reynaers.com](http://www.reynaers.com)

# Clean design, high-performing and futureproof

**MasterPatio** has been developed to combine clean aesthetics, futureproof design, and best-in-class performance. The versatile system is suitable for passive projects, as its High Insulation variant is Minergie Module Certified. Moreover, MasterPatio's consistent look and feel has earned it both a Reddot and Archiproducts design award (2021).

Reynaers Aluminium profiles are already produced with low-carbon energy sources, but with MasterPatio we take your sustainable project to the next level. Recycled insulation strips and more efficient production methods help us limit the ecological impact of this durable solution.

MasterPatio is more than just a sliding door. It offers multiple opening variants which can be combined effortlessly with our MasterLine 8 and ConceptWall joinery systems. The perfect match to all your needs.



## The next generation of high-performing sliding systems.

MasterPatio is able to reach passive house  $U_w$  thermal levels and offers water-tightness of up to 1200 Pa. This makes it the best performing lift-slide system in the market. Thanks to the recycled insulation bars and reduced waste levels during the production process, MasterPatio is your perfect sustainable upgrade.

## Clean, consistent and contemporary look for a complete façade solution.

The built-in compatibility with our MasterLine 8 windows and doors and ConceptWall curtain wall systems transforms MasterPatio from a lift-slide system to a complete floor-to-ceiling façade solution. Build your home or high-rise apartment exactly as you want it to be. Combinations with fixed panels, open corners, and ventilation vents are also possible.

## Easy-to-operate and safe system.

As a result of its patented glass support and dedicated hardware, MasterPatio opens and closes effortlessly. Moreover, the lift-slide system can be combined with motorisation technology to provide ultimate comfort. The low and zero threshold variants allow for worry-free accessibility for all.

## MasterPatio General

### Possible vent sizes (mm)

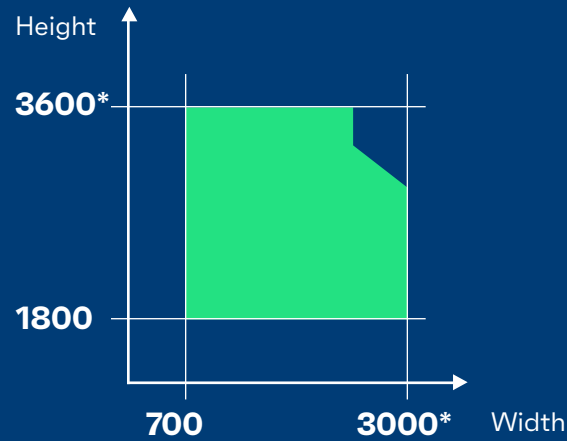

\*Max dimensions depend on multiple parameters including wind load requirements and glass type choice.

### Maximum vent weights (kg)

Lift-slide vent	Fixed vent	Fixed monorail
500	500	1200

### Visible dimensions (mm)

1 Vent height	87
2 Frame height	60
3 Frame depth	180
4 Glass thickness	Up to 62

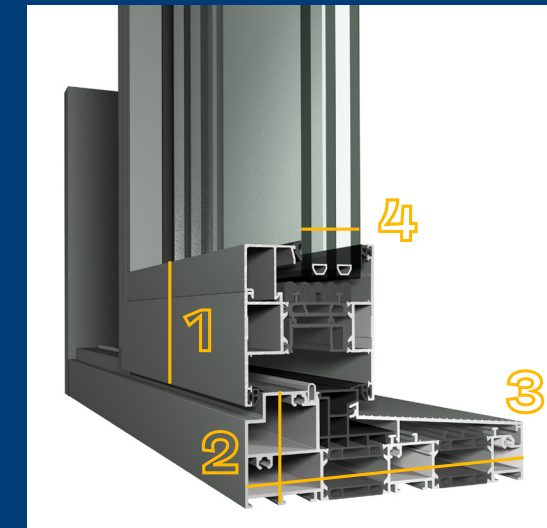

## MasterPatio Variants

### Monorail Outside Glazed

<b>Thermal value - Uw (W/m<sup>2</sup>K)</b>	Down to 0.75
<b>Water tightness</b>	E1200 (1200 Pa)
<b>Wind load resistance</b>	C5 (2000 Pa)
<b>Burglarproof</b>	RC2 / PAS24

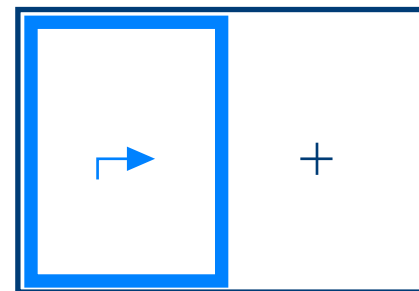

### Monorail Inside Glazed

<b>Thermal value - Uw (W/m<sup>2</sup>K)</b>	Down to 0.8
<b>Water tightness</b>	E750 (750 Pa)
<b>Wind load resistance</b>	C5 (2000 Pa)
<b>Burglarproof</b>	RC2 / PAS 24

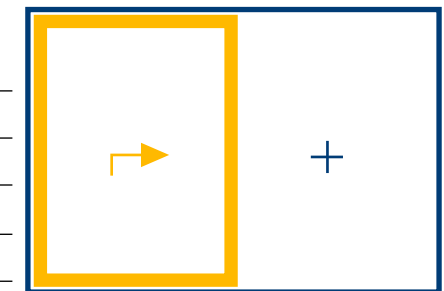

### 2-rail

<b>Thermal value - Uw (W/m<sup>2</sup>K)</b>	Down to 0.8
<b>Water tightness</b>	E1050 (1050 Pa)
<b>Wind load resistance</b>	C5 (2000 Pa)
<b>Burglarproof</b>	RC2 / PAS24

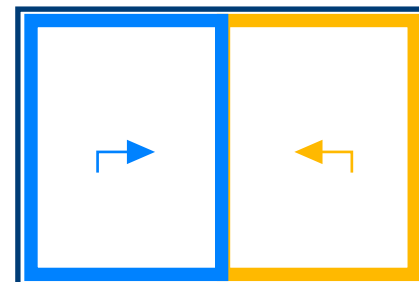

### More variants can be found on our website...

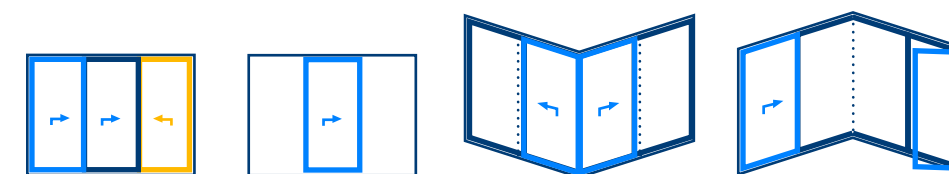

\*\*Performance levels and properties depend on size, profile combinations, hardware and infill choices. Please contact your Reynaers Aluminium representative for your ideal solution.

## MasterPatio Options



### Access Control

When it comes to protecting your home or business, you want to have control over who has access to your building, and when. We offer a number of electronic access control systems to protect your residence or business facility.

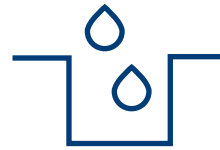

### Gutter

During heavy rain your system might have to process large quantities of water. An integrated gutter can help to guide this flow away from the window, even combined with tiled terrace floors. In most cases we offer aesthetically covered gutter solutions.

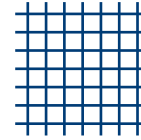

### Flyscreen

We offer flyscreens in two variants: traditional & visible, or integrated & concealed flyscreens. Often overlooked at first, it is one of the most popular options amongst our customers.



### Motorised

Motors make it easier to operate our products in case you do not want to open them manually. The components are integrated inside the profiles, so it does not impact the overall design.



## Sustainability

MasterPatio stands for contemporary design and high performance. The recycled polyamide insulation strips reduce the system's carbon impact and help your home reach comfort levels up to passive house standards. What is more, production waste is reduced thanks to its clever circular design. As a result, this "next generation of sliding doors" is Cradle To Cradle® and Minergie Certified, making it the ideal sustainable upgrade to your project.



## Smart Buildings

Our slide and lift-slide systems are compatible with the industry's leading smart building systems. With a range of intelligent solutions, our systems do the work for you at the push of a button. No need to worry about keys anymore: the smart system allows you to manage access to your home or building through a fingerprint scanner or mobile app. Moreover, helped by an integrated motor, you can slide even the heaviest panes aside as smoothly as ever.

### Get in touch

Interested or looking for more in-depth technical information? Contact your Reynaers Aluminium representative for more information or scan the QR code to visit our website.

