

CS 38-SL

CS 38-SL



REYNAERS
aluminium

Edition 08/2010 (based on 089.E16A.00)

CS 38 Slim Line



CS 38-SL

- 1 Vaste elementen
- 2 Opende elementen
- 3 Deuren
- 4 Koppelingen met andere systemen
- 5 CS 38-Slim Line Anti-burglary Proof (CS 38-SL/AP)

CS 38-SL

- 1 Éléments fixes
- 2 Éléments ouvrants
- 3 Portes
- 4 Combinaisons avec d'autres systèmes
- 5 CS 38-Slim Line Anti-burglary Proof (CS 38-SL/AP)

CS 38-SL

- 1 Fixed elements
- 2 Opening elements
- 3 Doors
- 4 Connections with other systems
- 5 CS 38-Slim Line Anti-burglary Proof (CS 38-SL/AP)

CS 38-SL

- 1 Feste Elemente
- 2 Öffnende Elemente
- 3 Türen
- 4 Kombinationen mit anderen Systemen
- 5 CS 38-Slim Line Anti-burglary Proof (CS 38-SL/AP)

CS 38 SLim Line (portes)



1 Eléments fixes

Dormant & Traverse

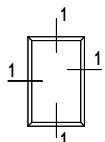

CS 38-SL - 002

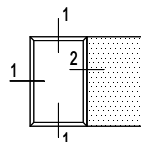

CS 38-SL - 002

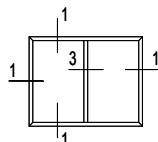

CS 38-SL - 002

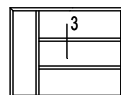

CS 38-SL - 002

Traverse & Petit bois

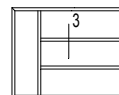

CS 38-SL - 004

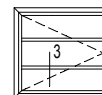

CS 38-SL - 004

2 Eléments ouvrants

Fenêtres ouvrant vers l'intérieur

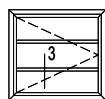

CS 38-SL - 006

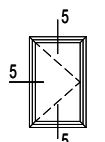

CS 38-SL - 006

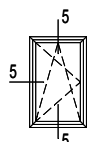

CS 38-SL - 006

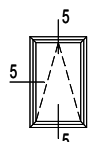

CS 38-SL - 006

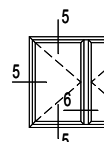

CS 38-SL - 006

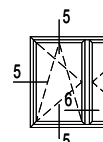

CS 38-SL - 006



CS 38-SL - 007

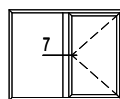

CS 38-SL - 007

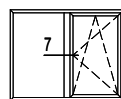

CS 38-SL - 007

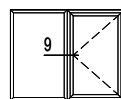

CS 38-SL - 007

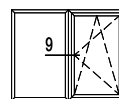

CS 38-SL - 007

Fenêtre ouvrant vers l'extérieur

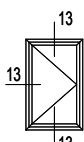

CS 38-SL - 008

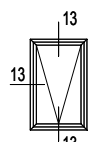

CS 38-SL - 008

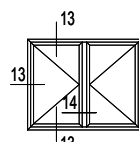

CS 38-SL - 008

CS 38 SLim Line (deuren)



3 Deuren

Naar binnen opengaande deuren

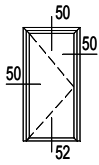

CS 38-SL - 020

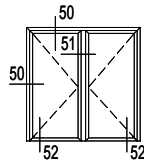

CS 38-SL - 020

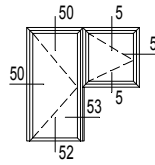

CS 38-SL - 020

Naar buiten opengaande deuren

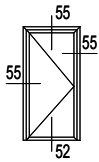

CS 38-SL - 022

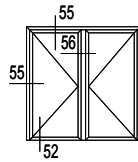

CS 38-SL - 022

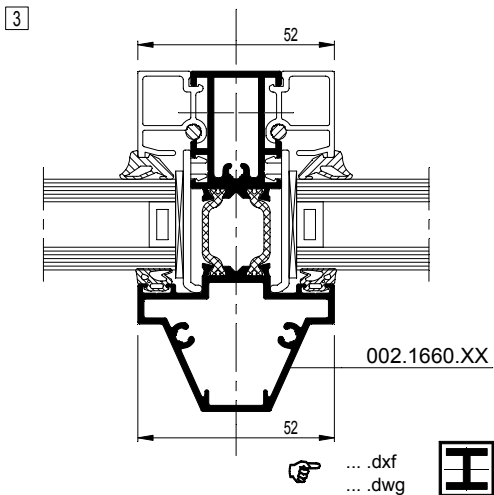
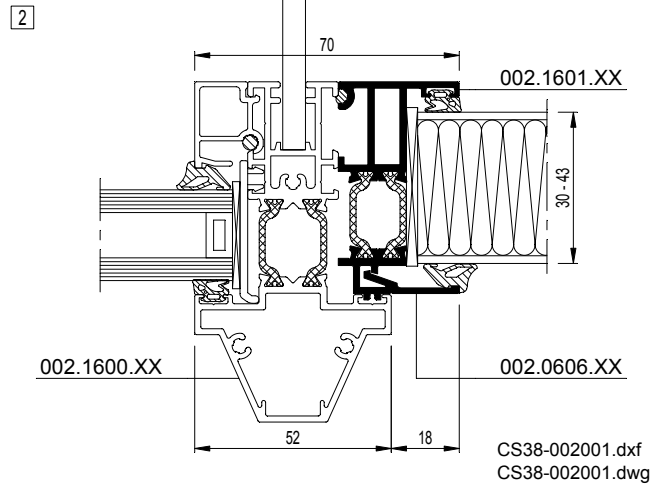
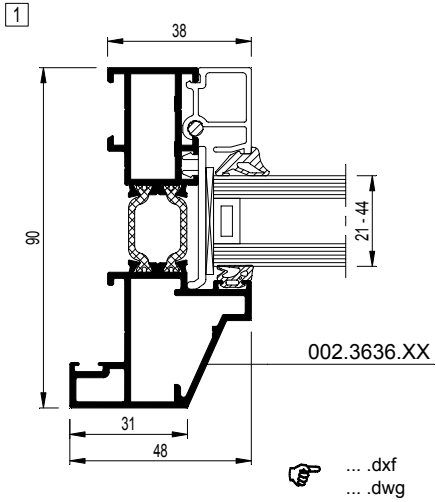
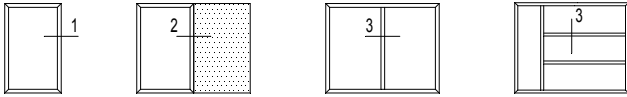

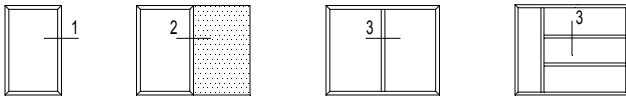

002.3636.XX

$I_x = 34.391 \text{ cm}^4$

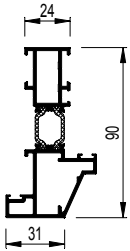

1

CS38-001001.dxf
 CS38-001001.dwg

002.3625.XX

$I_x = 37.73 \text{ cm}^4$

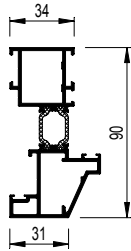

1

CS38-001002.dxf
 CS38-001002.dwg

002.1736.XX

$I_x = 27.068 \text{ cm}^4$

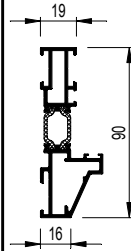

1

CS38-001003.dxf
 CS38-001003.dwg

002.0640.XX

$I_x = 29.647 \text{ cm}^4$

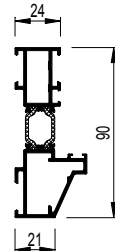

1

CS38-001004.dxf
 CS38-001004.dwg

002.1653.XX

$I_x = 28.895 \text{ cm}^4$

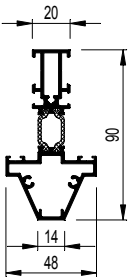

3

CS38-003001.dxf
 CS38-003001.dwg

002.1660.XX

$I_x = 31.362 \text{ cm}^4$

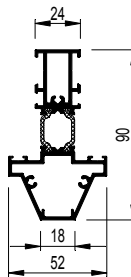

3

CS38-003002.dxf
 CS38-003002.dwg

002.1600.XX

$I_x = 32.003 \text{ cm}^4$

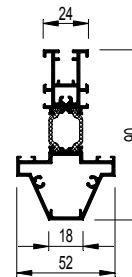

3

CS38-003003.dxf
 CS38-003003.dwg

	$I_x \text{ cm}^4$	$W_x \text{ cm}^3$	$I_y \text{ cm}^4$	$W_y \text{ cm}^3$
002.1600.XX + 30 x 6 ALU	42.167	7.785	8.594	3.305
002.1600.XX + 50 x 6 ALU	63.797	10.277	8.630	3.319
002.1600.XX + 70 x 6 ALU	95.440	13.220	8.666	3.333

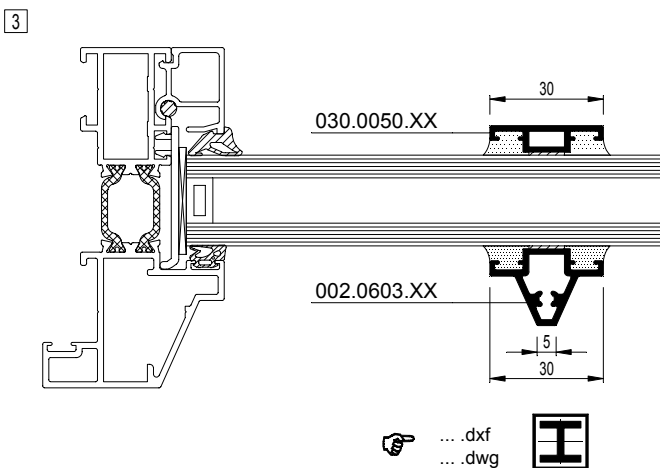
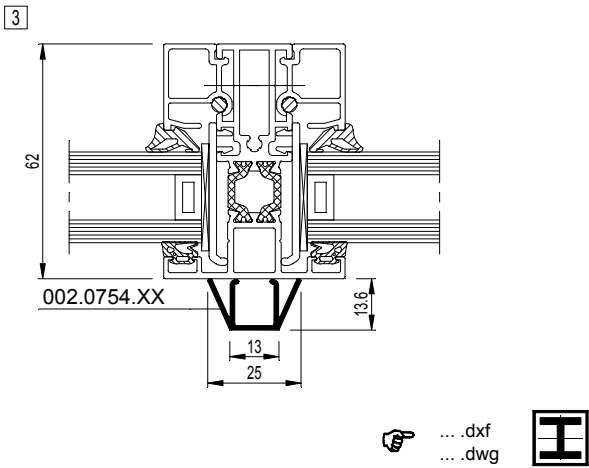
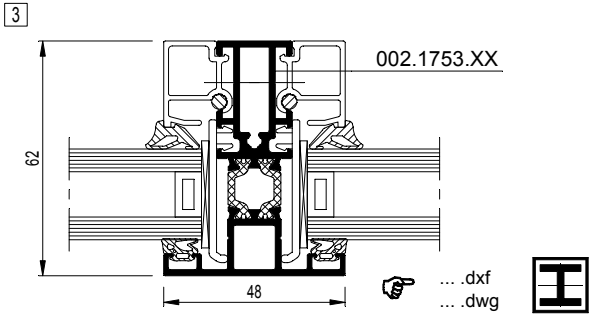
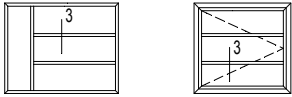

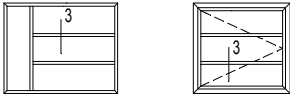

002.1753.XX

$I_x = 13.273 \text{ cm}^4$

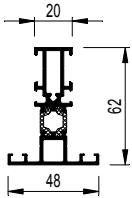

CS38-003004.dxf
 CS38-003004.dwg

002.1761.XX

$I_x = 14.355 \text{ cm}^4$

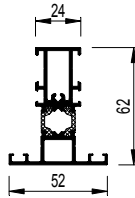

CS38-003005.dxf
 CS38-003005.dwg

002.0754.XX

$I_x = 0.141 \text{ cm}^4$

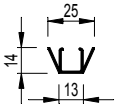

CS38-003006.dxf
 CS38-003006.dwg

002.0763.XX

$I_x = 0.159 \text{ cm}^4$

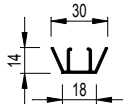

CS38-003007.dxf
 CS38-003007.dwg

002.0762.XX

$I_x = 0.172 \text{ cm}^4$

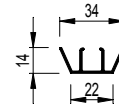

CS38-003008.dxf
 CS38-003008.dwg

030.0050.XX

$I_x = 0.046 \text{ cm}^4$

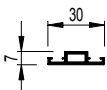

CS38-003009.dxf
 CS38-003009.dwg

002.0603.XX

$I_x = 0.444 \text{ cm}^4$

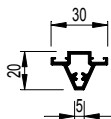

CS38-003010.dxf
 CS38-003010.dwg

002.0703.XX

$I_x = 1.000 \text{ cm}^4$

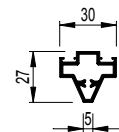

CS38-003011.dxf
 CS38-003011.dwg

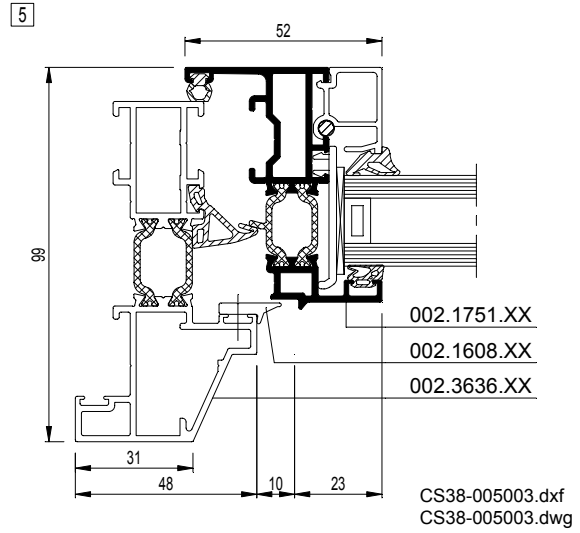
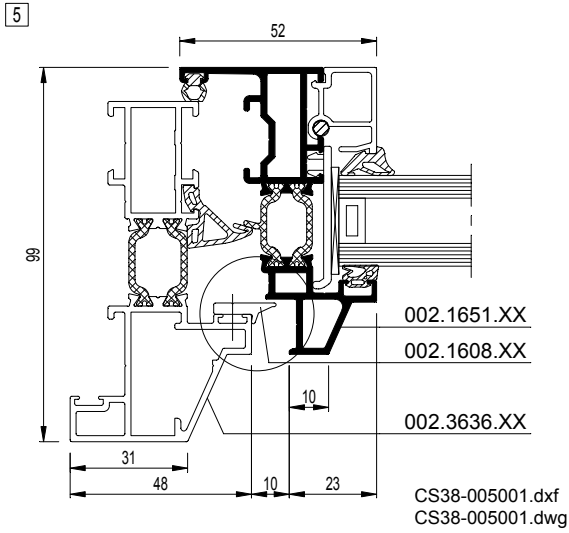
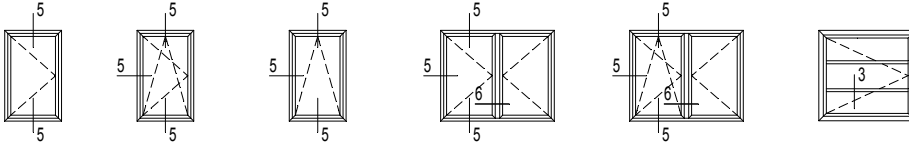

Variant
 Variante

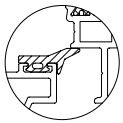

CS38-005002.dxf
 CS38-005002.dwg

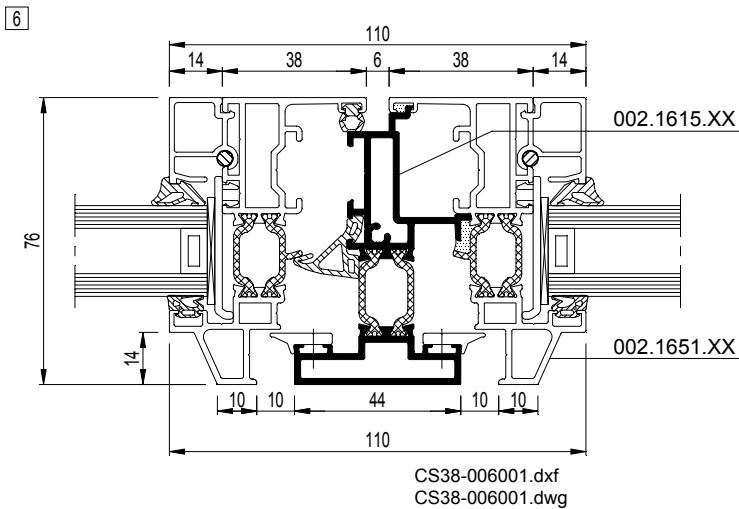

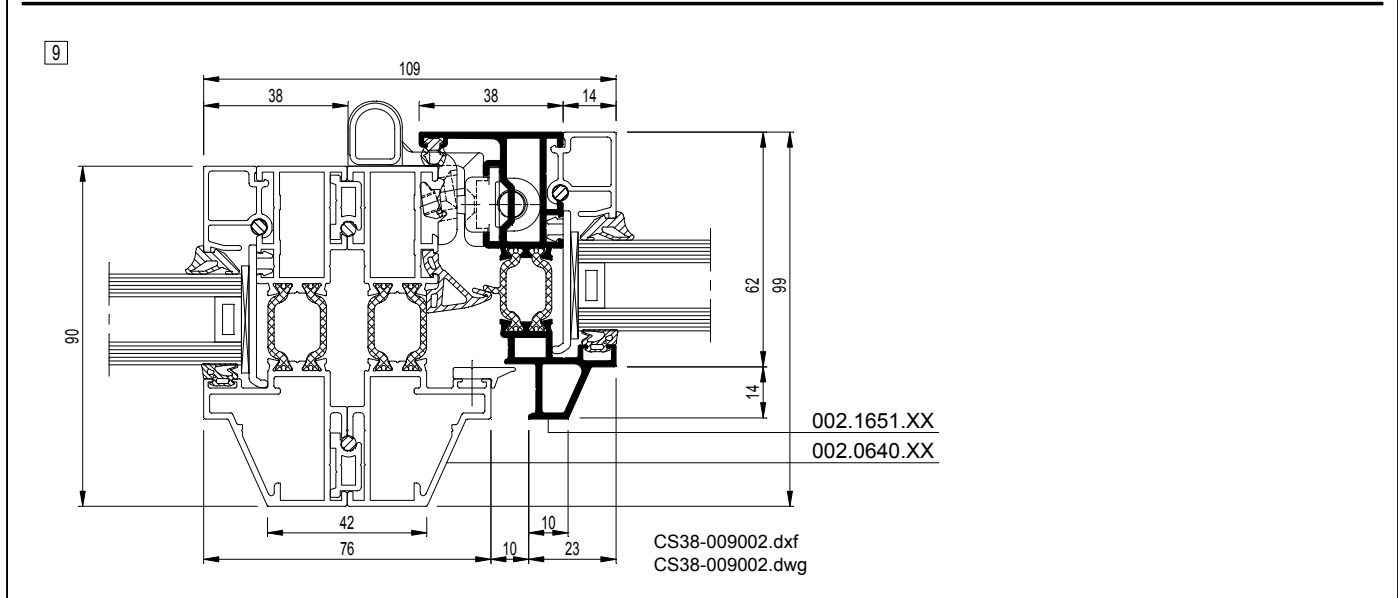
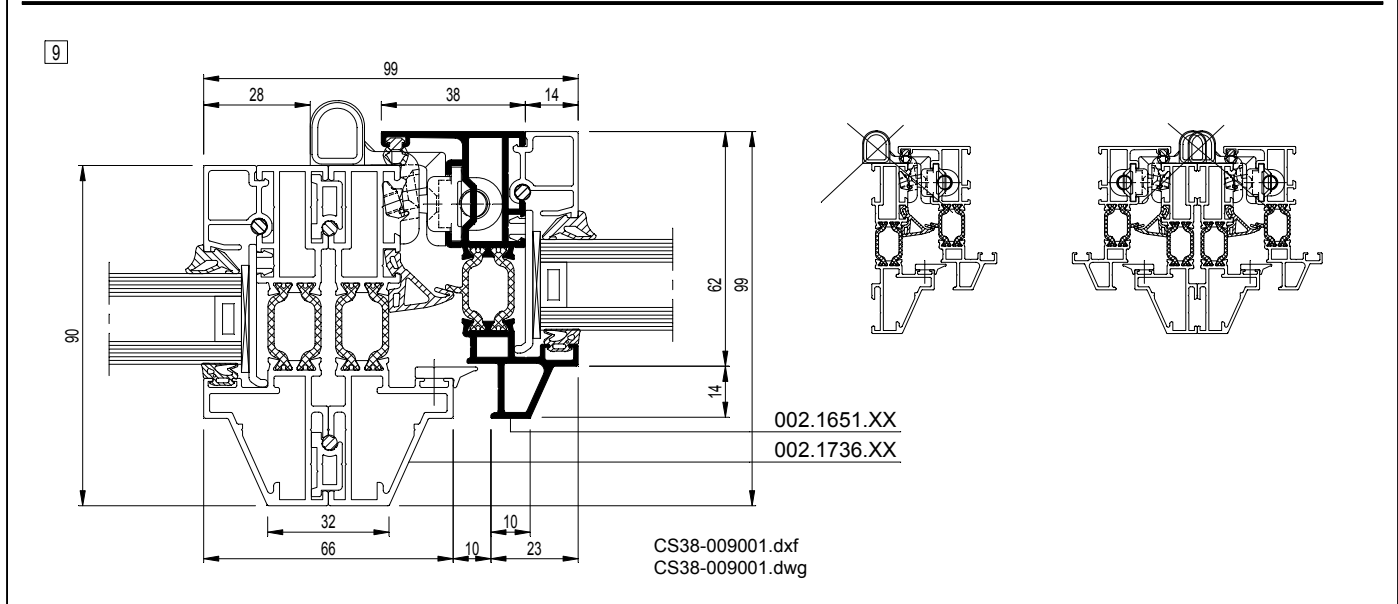
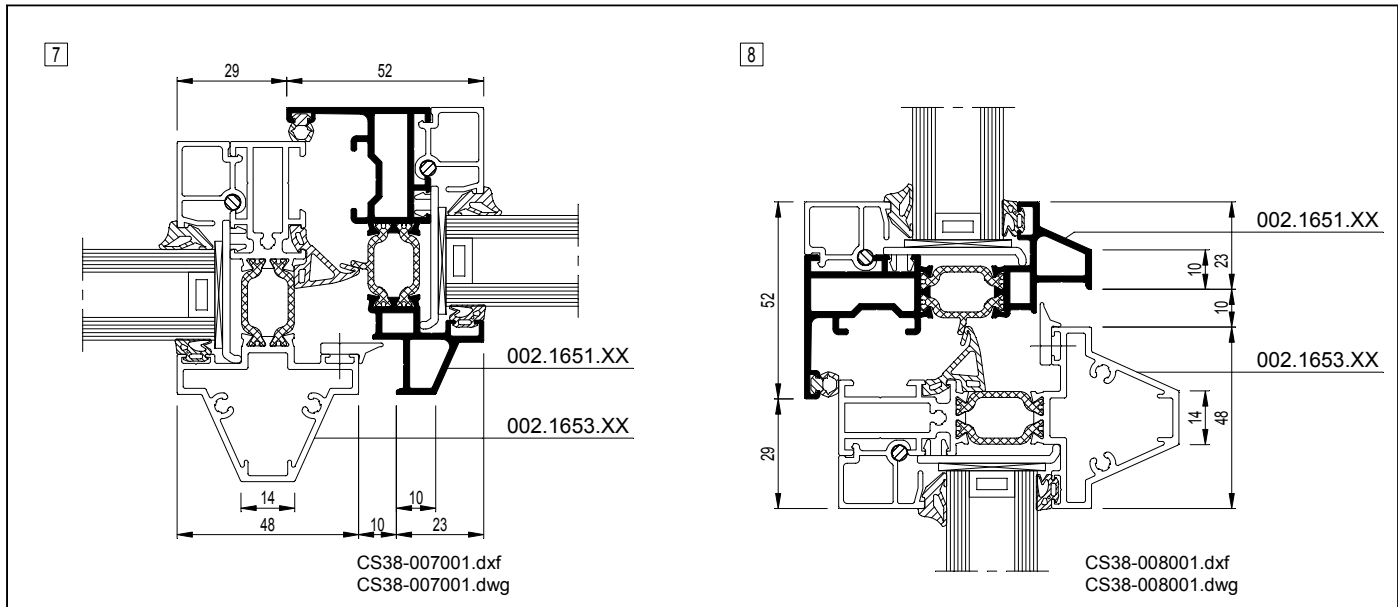
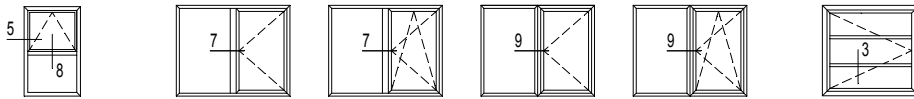

CS 38-SL

Opengaande elementen - Naar buiten opengaande ramen
 Éléments ouvrants - Fenêtre ouvrant vers l'extérieur
 Opening elements - Outward opening windows
 Öffnende Elemente - Nach außen öffnende Fenster

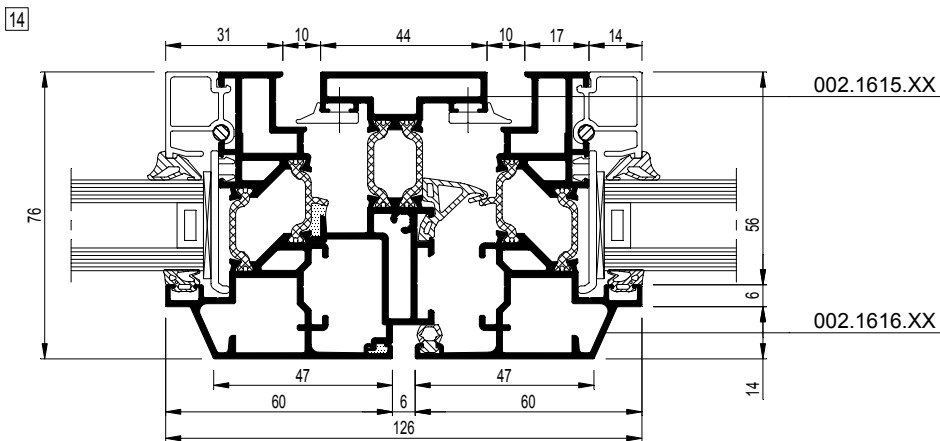
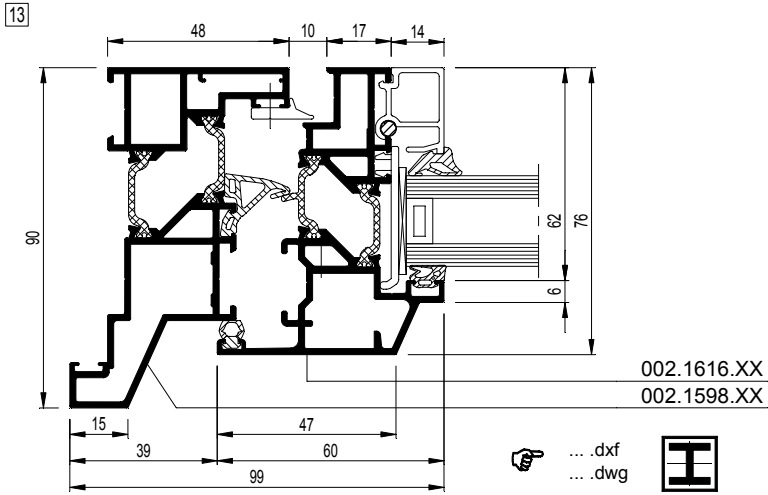
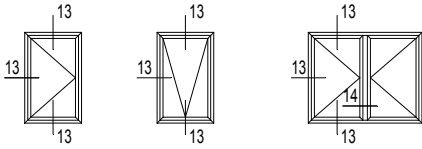

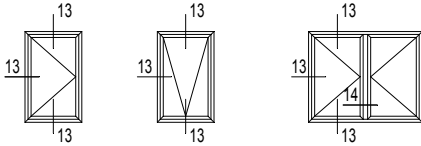

CS38-014001.dxf
 CS38-014001.dwg

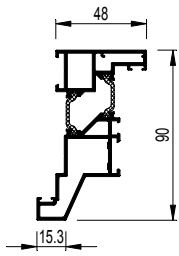

002.1598.XX

$I_x = 39.029 \text{ cm}^4$



 CS38-013001.dxf
CS38-013001.dwg

002.2698.XX

$I_x = 33.148 \text{ cm}^4$

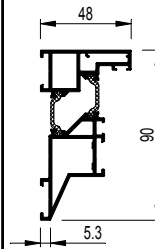

 CS38-013002.dxf
CS38-013002.dwg

CS 38-SL

Deuren - Naar binnen opengaande deuren
 Portes - Portes ouvrant vers l'intérieur
 Doors - Inward opening doors
 Türen - Nach innen öffnende Türen

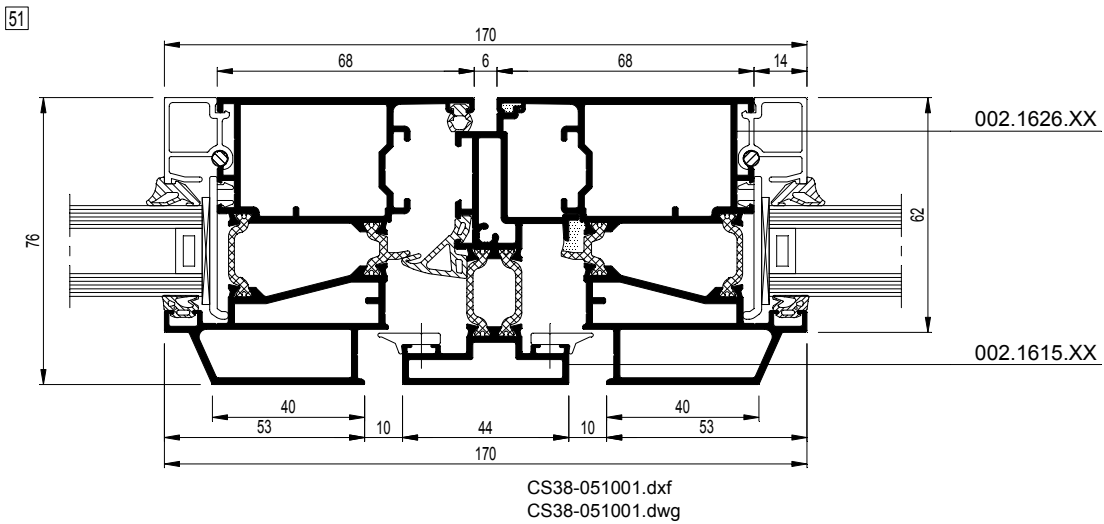
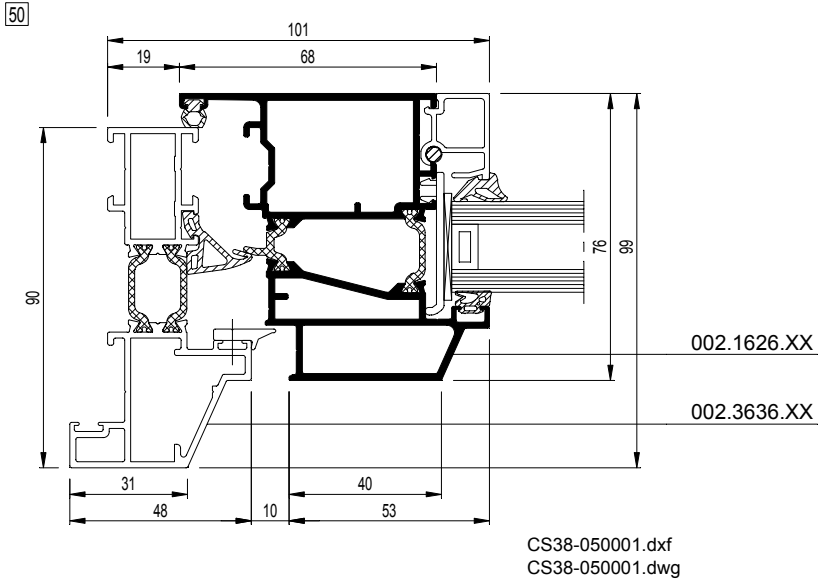
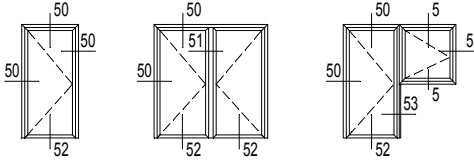

CS 38-SL

Deuren - Naar binnen opengaande deuren
 Portes - Portes ouvrant vers l'intérieur
 Doors - Inward opening doors
 Türen - Nach innen öffnende Türen

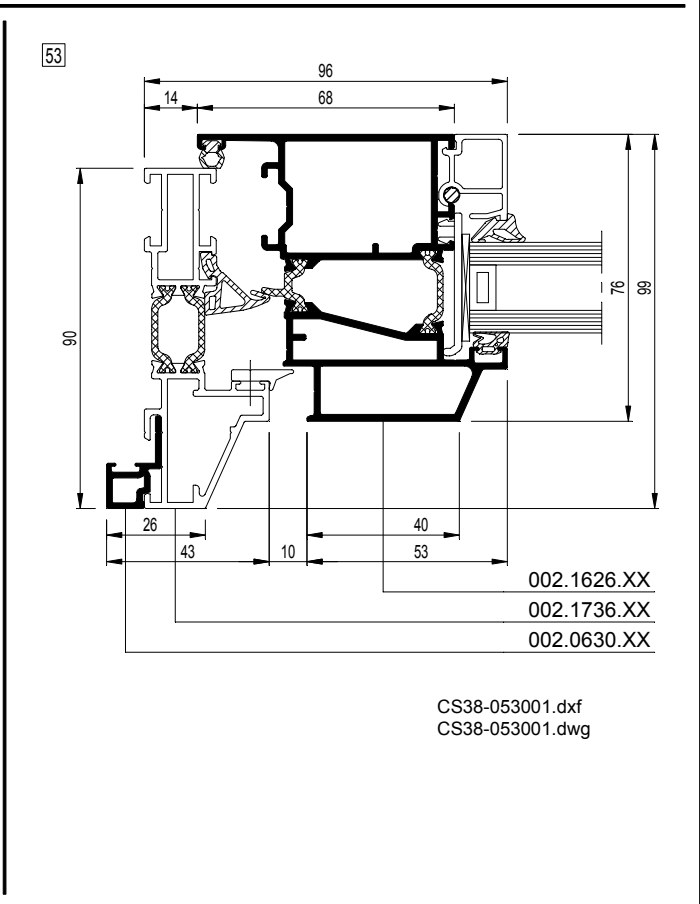
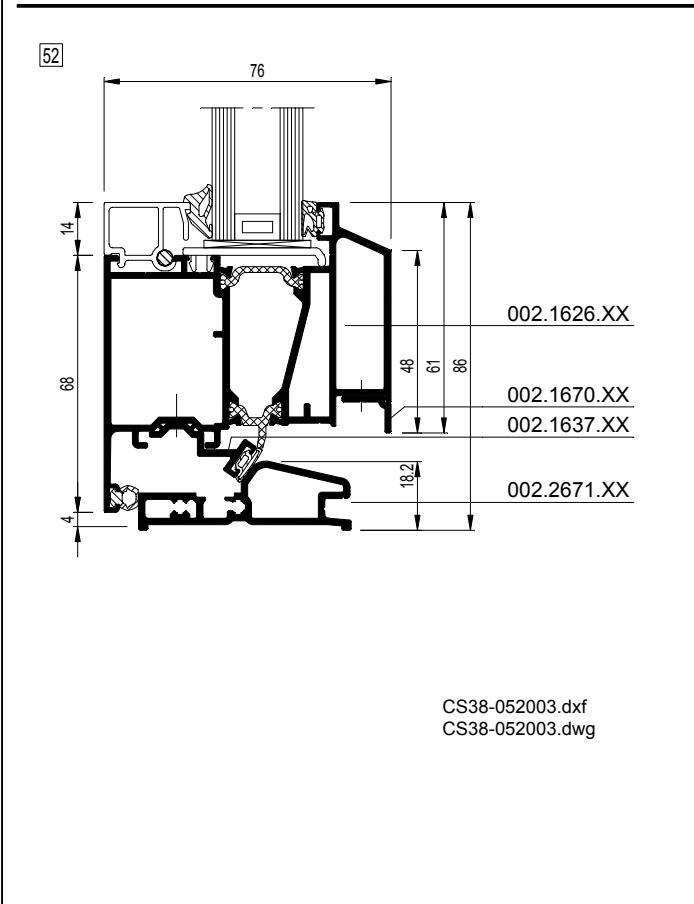
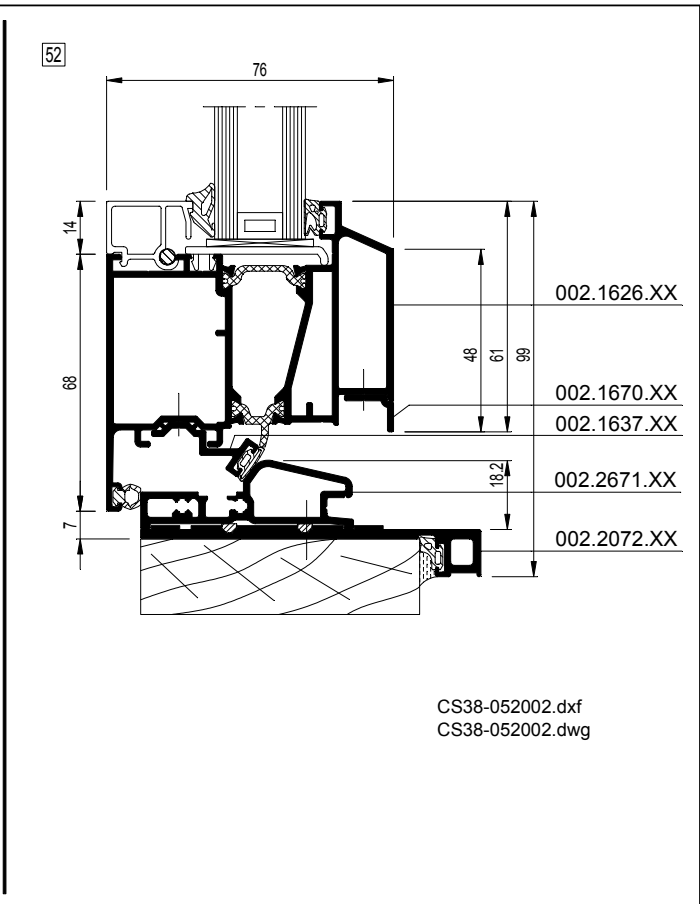
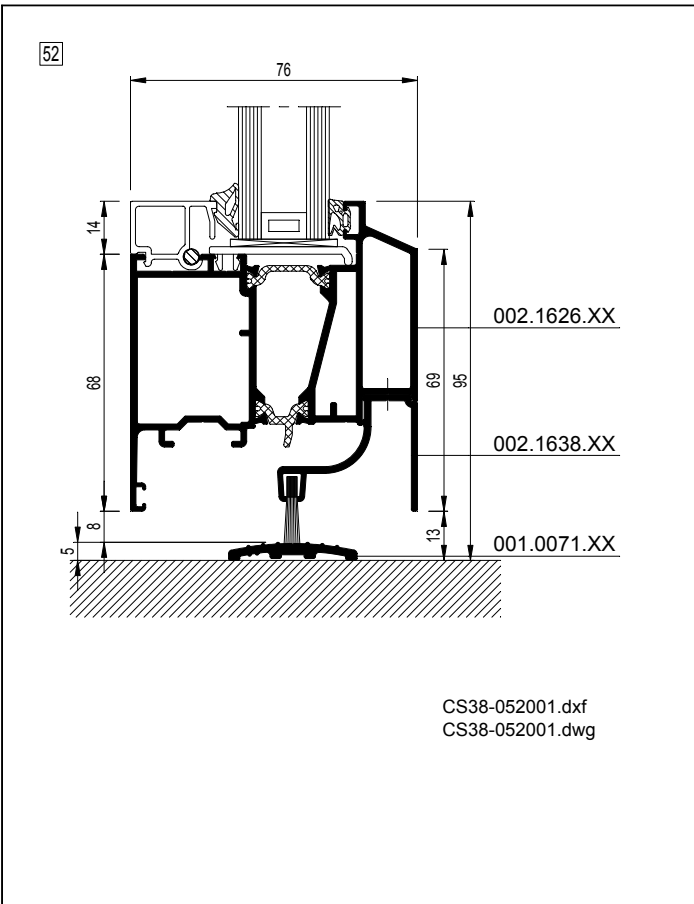
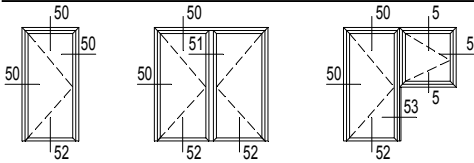

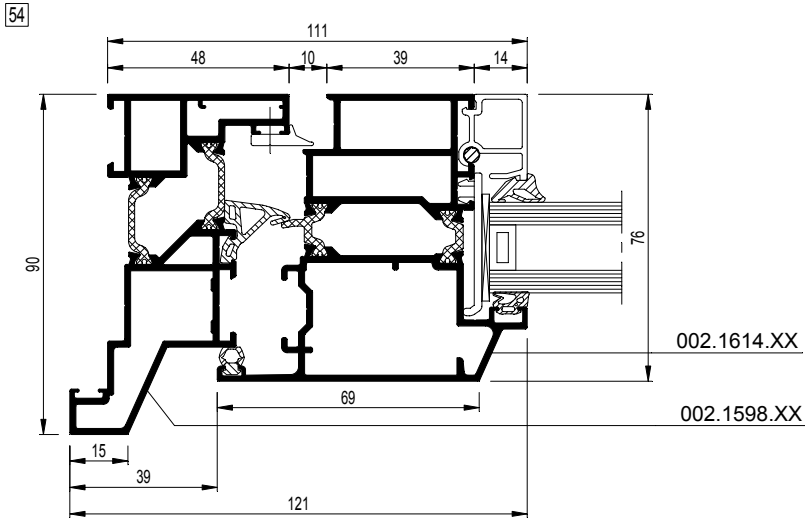
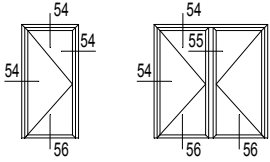

CS38-054001.dxf
 CS38-054001.dwg

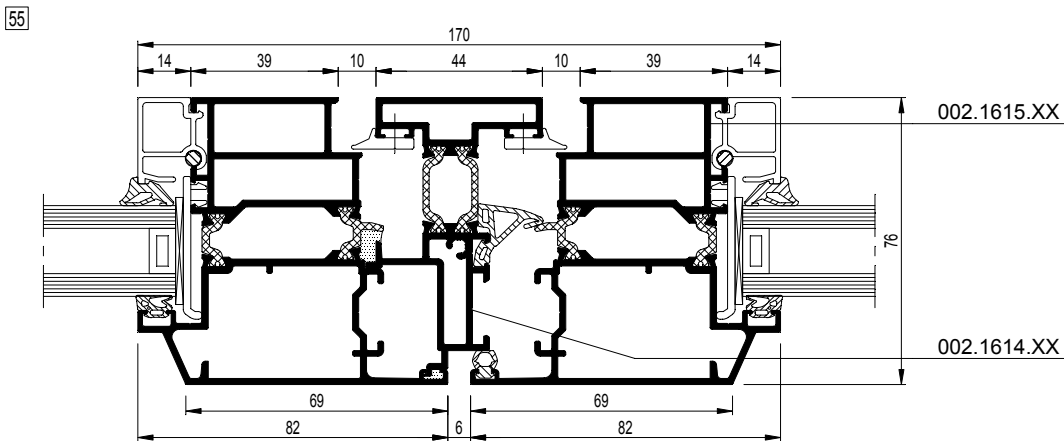

CS38-055001.dxf
 CS38-055001.dwg

CS 38-SL

Deuren - Naar buiten opengaande deuren
 Portes - Portes ouvrant vers l'extérieur
 Doors - Outward opening doors
 Türen - Nach außen öffnende Türen

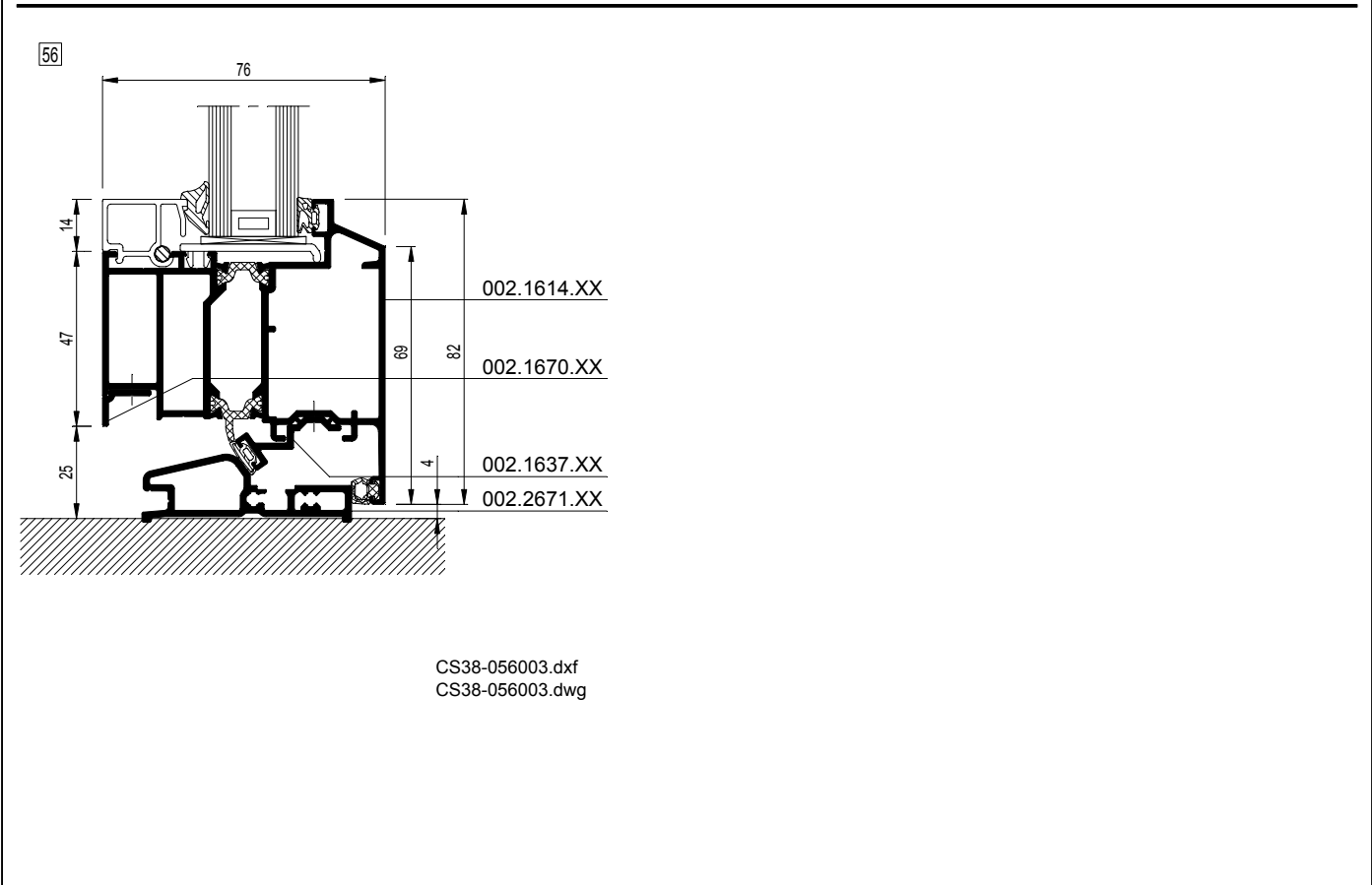
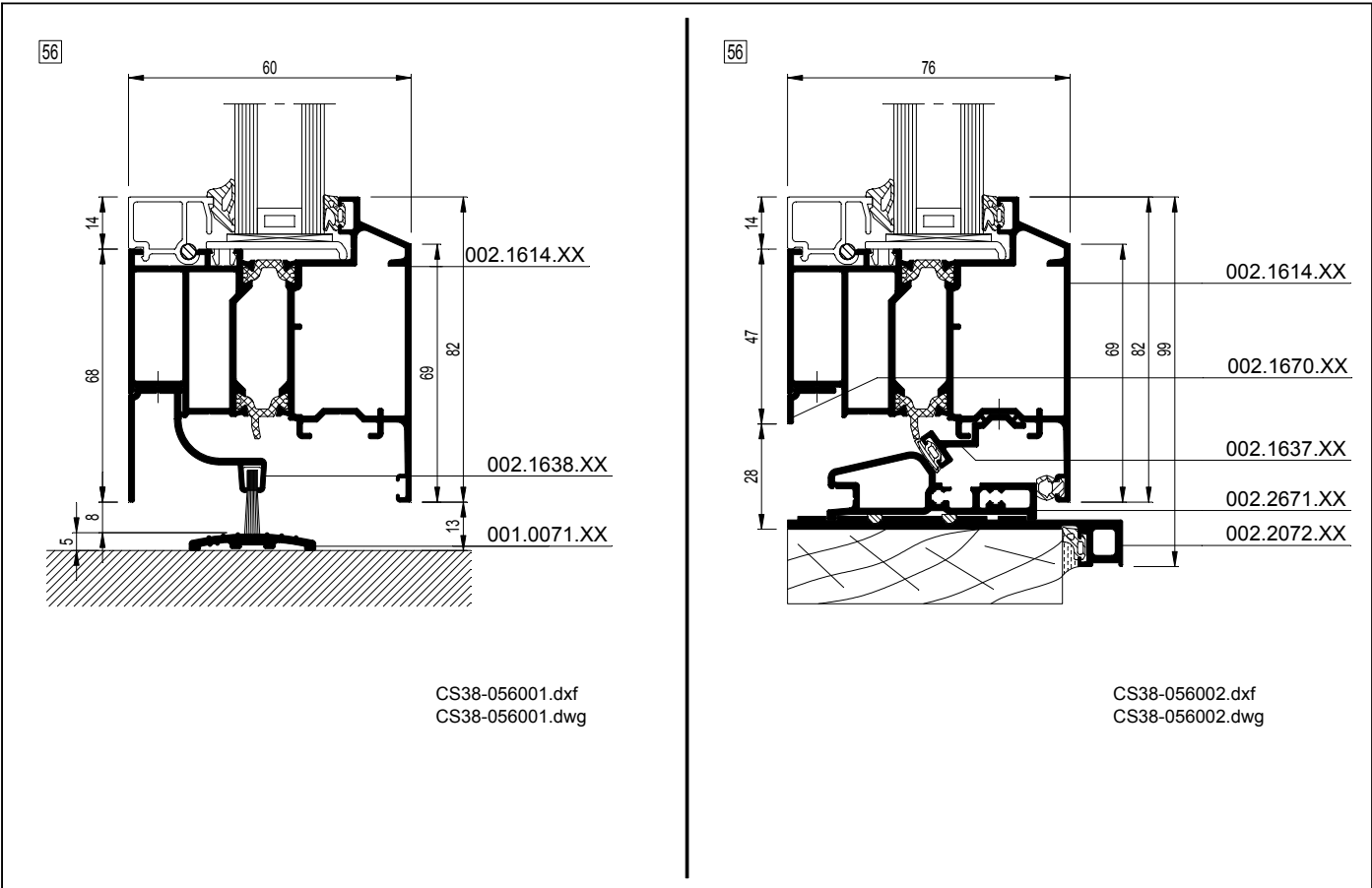
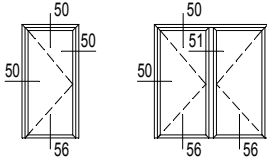

CS 38-SL



Koppelingen met andere systemen

CW 50 - CS 38-SL

Combinaisons avec d'autres systèmes

CW 50 - CS 38-SL

Connections with other systems

CW 50 - CS 38-SL

Kombinationen mit anderen Systemen

CW 50 - CS 38-SL

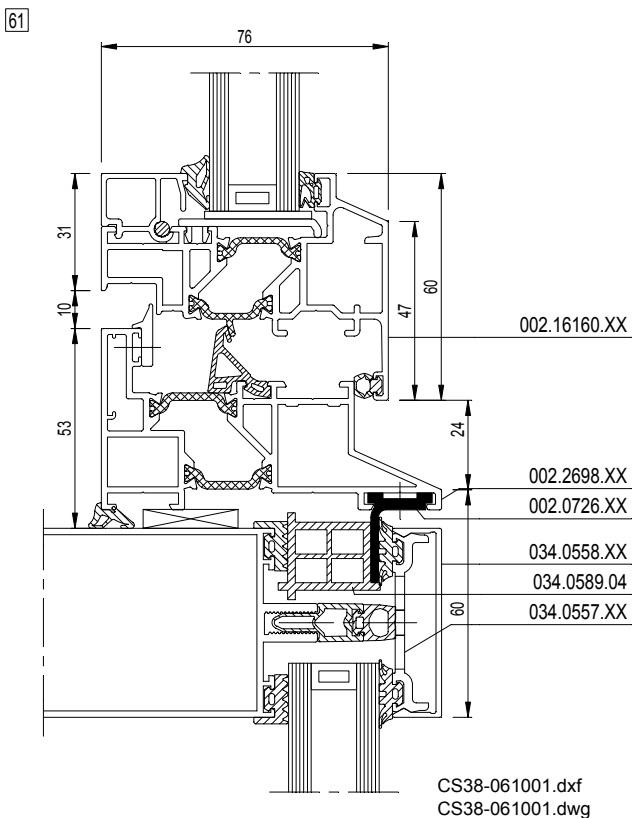
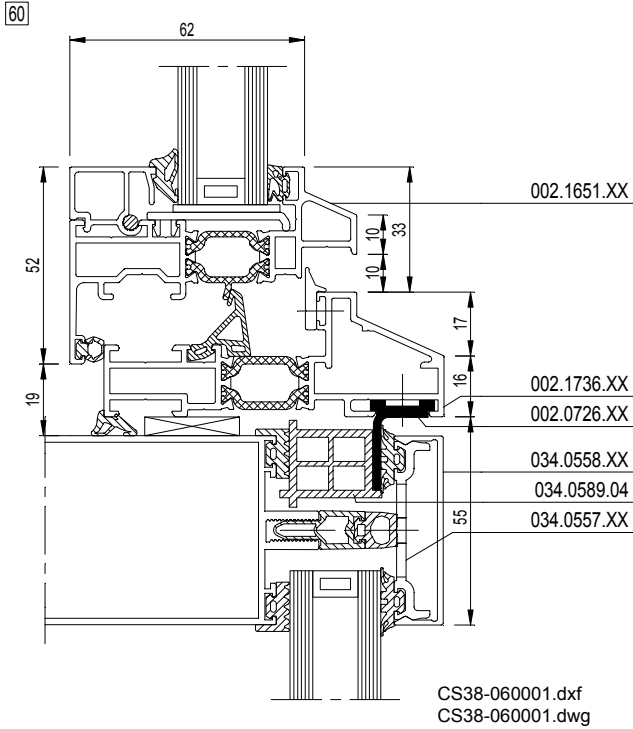
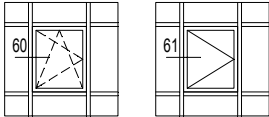



CS 38 Slim Line Anti-burglary Proof

Aperçu rapports d'essai

CS 38-LS - 040

Fenêtres

1 Eléments fixes

Dormant & Traverse

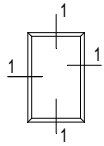

CS 38-SL - 002

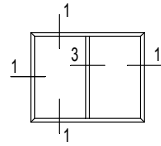

CS 38-SL - 002

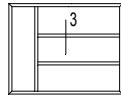

CS 38-SL - 002

Sprosse & Ziersprosse

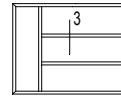

CS 38-SL - 004

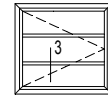

CS 38-SL - 004

2 Eléments ouvrants

Portes ouvrant vers l'intérieur

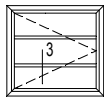

CS 38-SL - 006

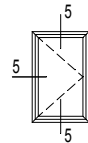

CS 38-SL - 006

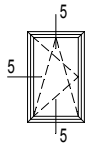

CS 38-SL - 006

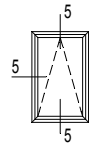

CS 38-SL - 006

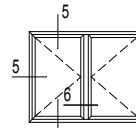

CS 38-SL - 006

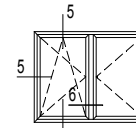

CS 38-SL - 006

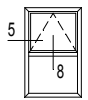

CS 38-SL - 007

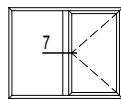

CS 38-SL - 007

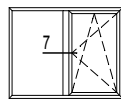

CS 38-SL - 007

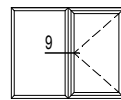

CS 38-SL - 007

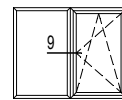

CS 38-SL - 007

3 Portes

Portes ouvrant vers l'intérieur

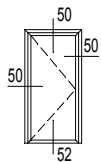

CS 38-SL - 020

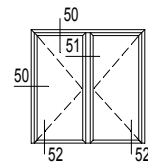

CS 38-SL - 020

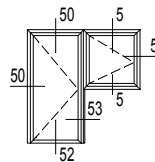

CS 38-SL - 020

Portes ouvrant vers l'extérieur

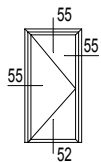

CS 38-SL - 022

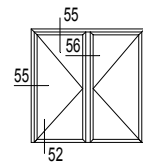

CS 38-SL - 022



NEN

WK II

TYPE OF ELEMENT

SYSTEM

STANDARD

REPORT NUMBER



CS 38-SL/AP

NEN 5096

KOMO Certificate S.K.G.:
'07.11.104.12

Du



CS 38-SL/AP

NEN 5096

KOMO Certificate S.K.G.:
'07.11.104.12

Du

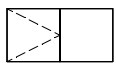

CS 38-SL/AP

NEN 5096

KOMO Certificate S.K.G.:
'07.11.104.12

Du



CS 38-SL/AP

NEN 5096

KOMO Certificate S.K.G.:
'07.11.104.12

Du



CS 38-SL/AP

NEN 5096

KOMO Certificate S.K.G.:
'07.11.104.12

Du

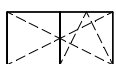
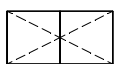

CS 38-SL/AP

NEN 5096

KOMO Certificate S.K.G.:
'07.11.104.12

Du



CS 38-SL/AP

NEN 5096

KOMO Certificate S.K.G.:
'07.11.104.12

Du



CS 38-SL/AP

NEN 5096

KOMO Certificate S.K.G.:
'07.11.104.12

Du



CS 38-SL/AP

NEN 5096

KOMO Certificate S.K.G.:
'07.11.104.12

Du





ANTI-BURGLAR PROF.	ANTI-BURGLAR ACC.	SUPPLIER	MIN/MAX CERT. DIMENSION (*)	
			FBmin: 250MM FHmin: 150MM	FBmax: --- FHmax: ---
	 	Sobinco	FBmin: 450MM FHmin: 700MM	FBmax: 1700MM FHmax: 2400MM
	 	Siegenia	FBmin: 1200MM FHmin: 1280MM	FBmax: 1440MM FHmax: 1536MM
	 	Sobinco	FBmin: 700MM FHmin: 400MM	FBmax: 2400MM FHmax: 1200MM
	 	Sobinco	FBmin: 700MM FHmin: 700MM	FBmax: 1800MM FHmax: 2400MM
	 	Sobinco	FBmin: 450MM FHmin: 600MM	FBmax: 1700MM FHmax: 2400MM
	 	Siegenia	FBmin: 1200MM FHmin: 1280MM	FBmax: 1440MM FHmax: 1536MM
	 	Sobinco	DIMENSIONS / VENT FBmin: 500MM FHmin: 800MM	
	 	Sobinco	FBmin: 500MM FHmin: 800MM	FBmax: 1400MM FHmax: 2400MM
	 5	Sobinco	FBmin: - FHmin: -	FBmax: 1030MM FHmax: 2600MM
	 	Fapim Sobinco		
	 5	Sobinco	FBmin: - FHmin: -	FBmax: 1030MM FHmax: 2600MM
	 	Fapim Sobinco		
	 5 	Sobinco	FBmin: - FHmin: -	FBmax: 1250MM / VENT FHmax: 2700MM / VENT
	 	Fapim Sobinco		
	 5 	Sobinco	FBmin: - FHmin: -	FBmax: 1250MM / VENT FHmax: 2700MM / VENT
	 	Fapim Sobinco		



ENV

WK II

TYPE OF ELEMENT

SYSTEM

STANDARD

REPORT NUMBER



CS 38-SL/AP

DIN V ENV 1627

IFT Rosenheim Prüfbericht
255 24700

Ge



CS 38-SL/AP

DIN V ENV 1627

IFT Rosenheim Prüfbericht
255 24700

Ge

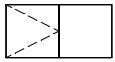

CS 38-SL/AP

DIN V ENV 1627







IFT Rosenheim Prüfbericht
255 24700

Ge





ENV

ANTI-BURGLAR PROF.	ANTI-BURGLAR ACC.	SUPPLIER	MIN/MAX CERT. DIMENSION (*)	
			FBmin: 250MM FHmin: 150MM	FBmax: -- FHmax: --
	 	Siegenia	FBmin: 840MM FHmin: 896MM	FBmax: 1320MM FHmax: 1408MM
	 	Siegenia	FBmin: 840MM FHmin: 896MM	FBmax: 1320MM FHmax: 1408MM

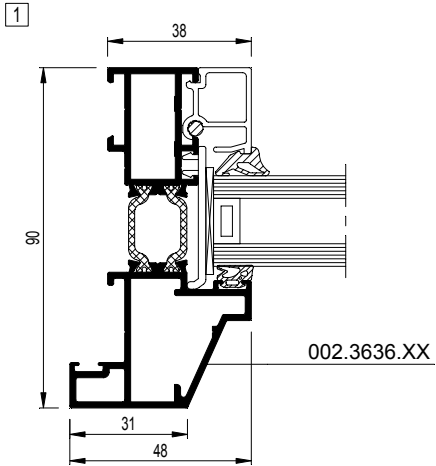
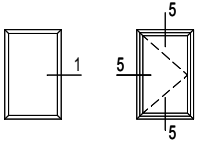

CS38-001001.dxf
CS38-001001.dwg

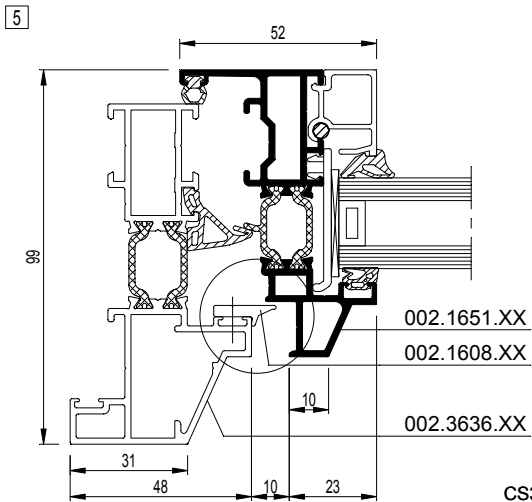

CS38-005001.dxf
CS38-005001.dwg

